

Plan A: Rumpf Seitenansicht & Schnitte

Plan B: Flächenaufhängung & Flächengeometrie

(C) 2006 Christian Steinmann - Alle Rechte vorbehalten - www.synprove.com/rc

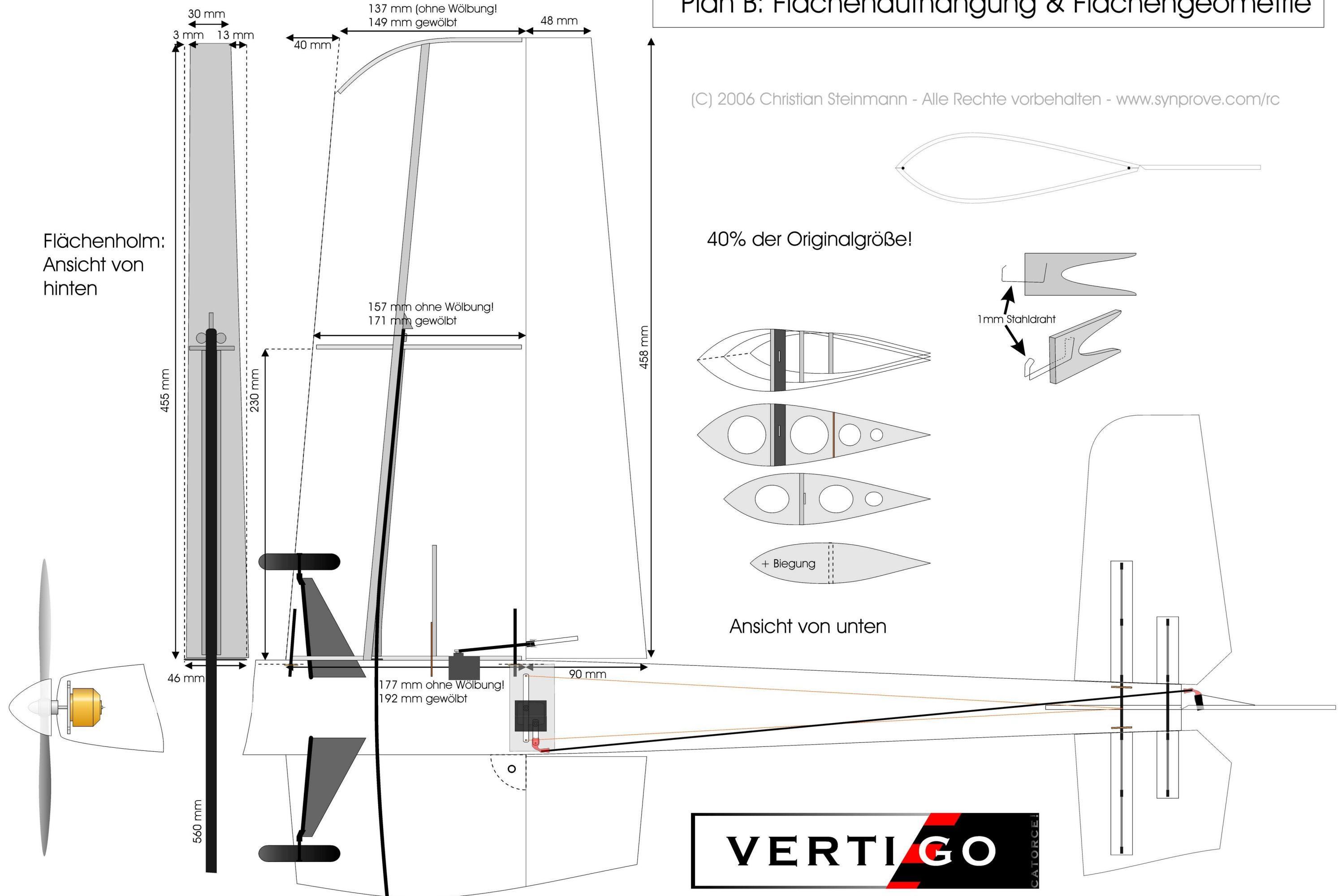



Plan C: Draufsicht

(C) 2006 Christian Steinmann - Alle Rechte vorbehalten - www.synprove.com/rc
40% der Originalgröße!

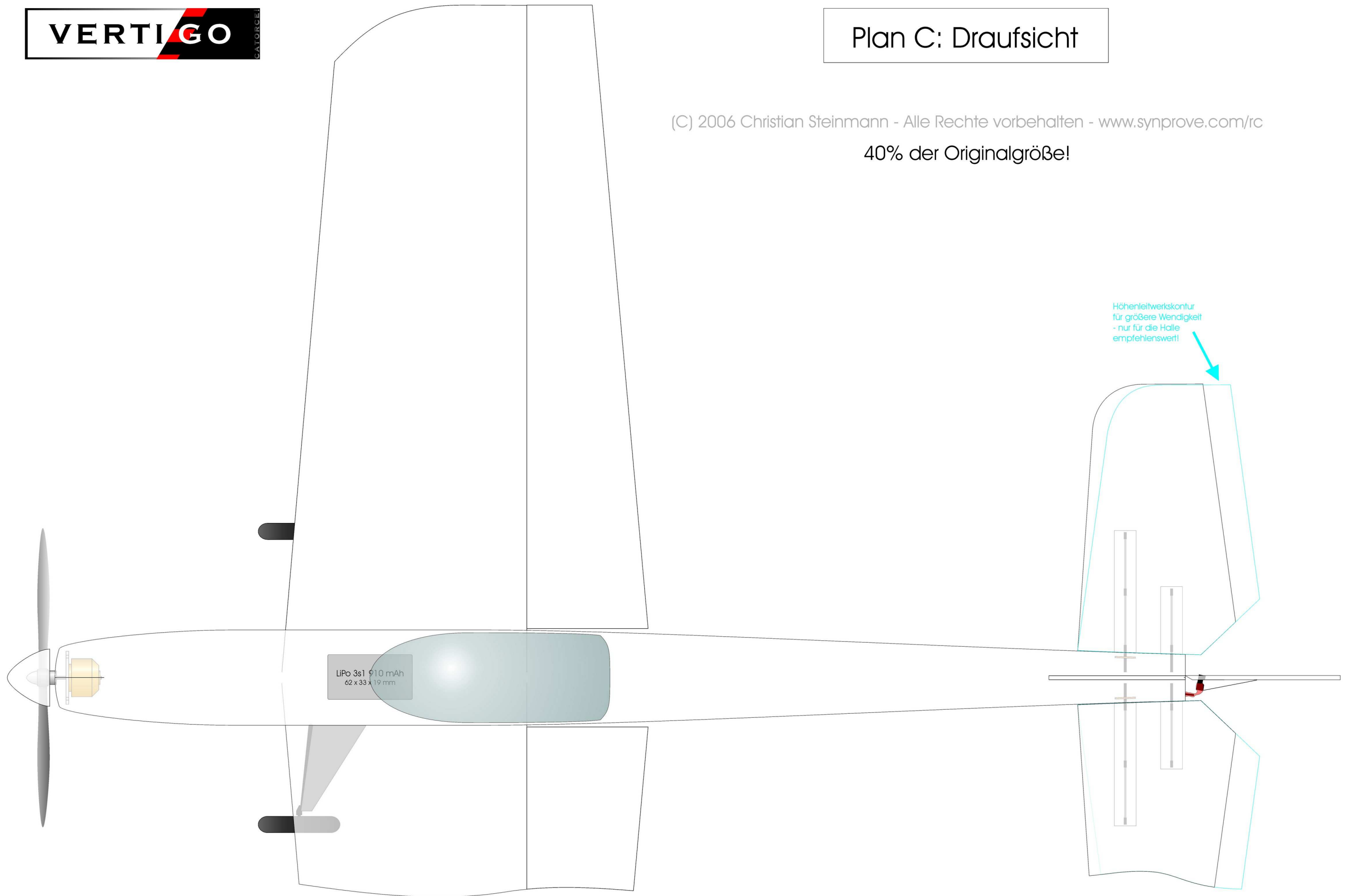

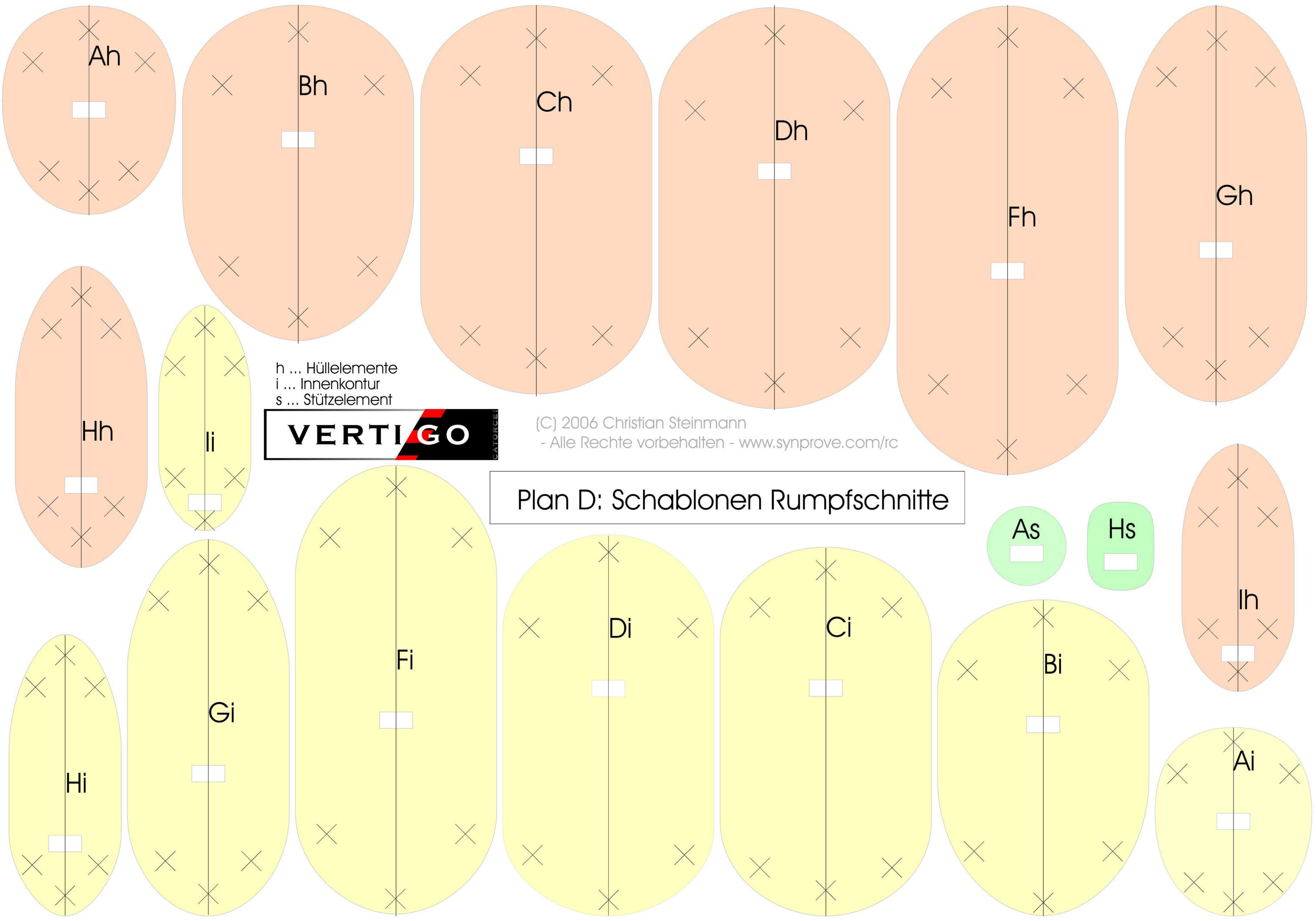

h ... Hüllelemente
 i ... Innenkontur
 s ... Stützelement



(C) 2006 Christian Steinmann
 - Alle Rechte vorbehalten - www.synprove.com/rc

Plan D: Schablonen Rumpfschnitte

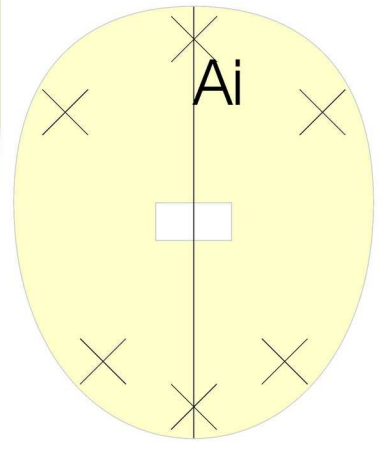
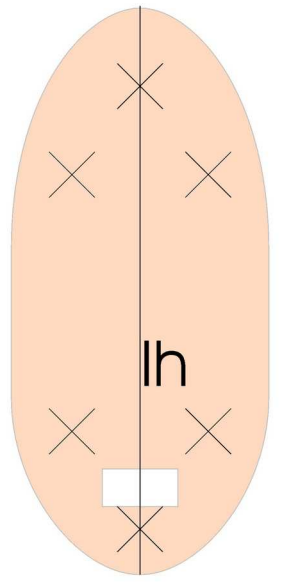
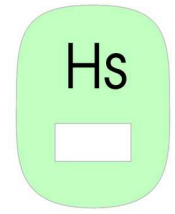
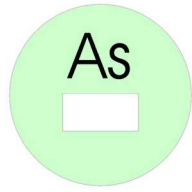

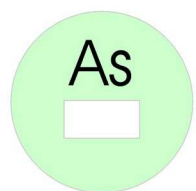
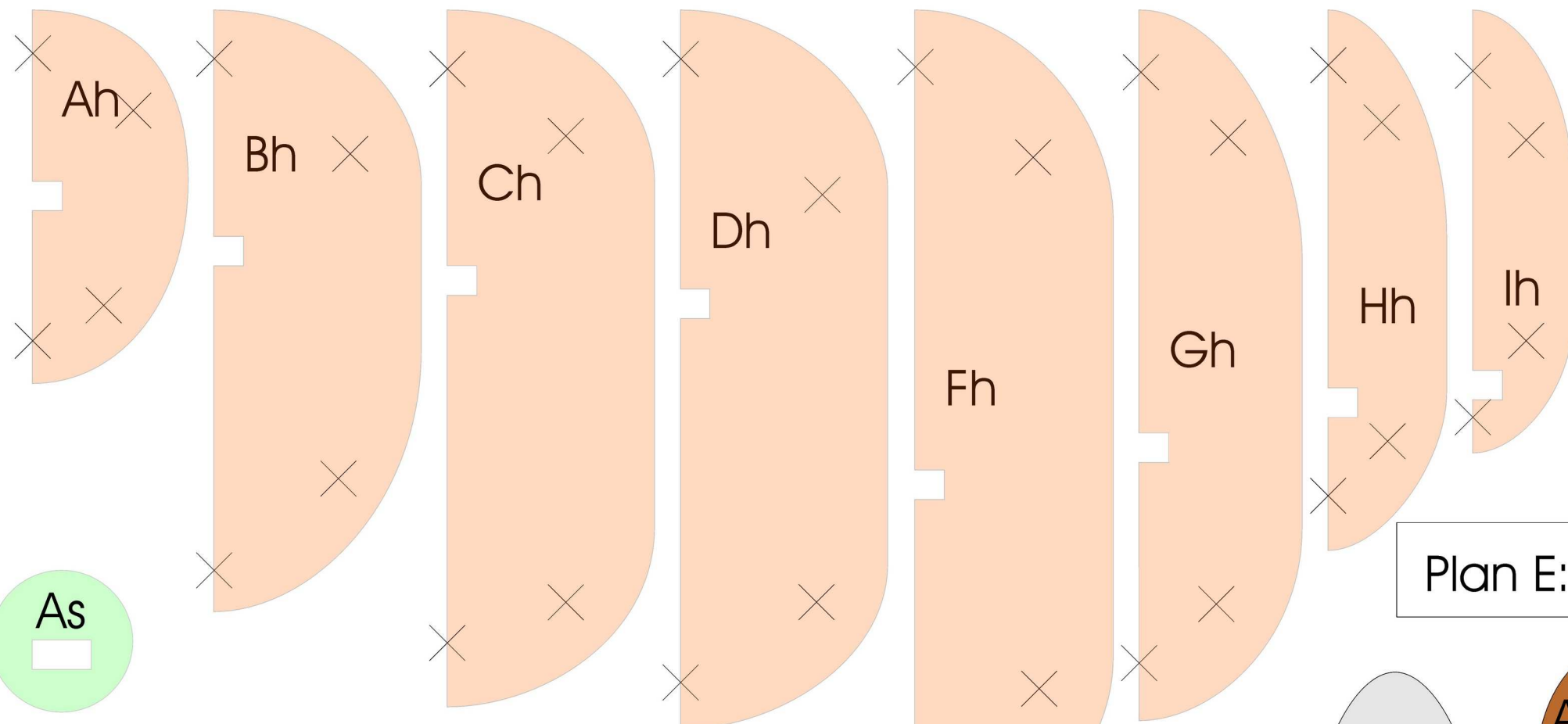

Plan E: Spanten

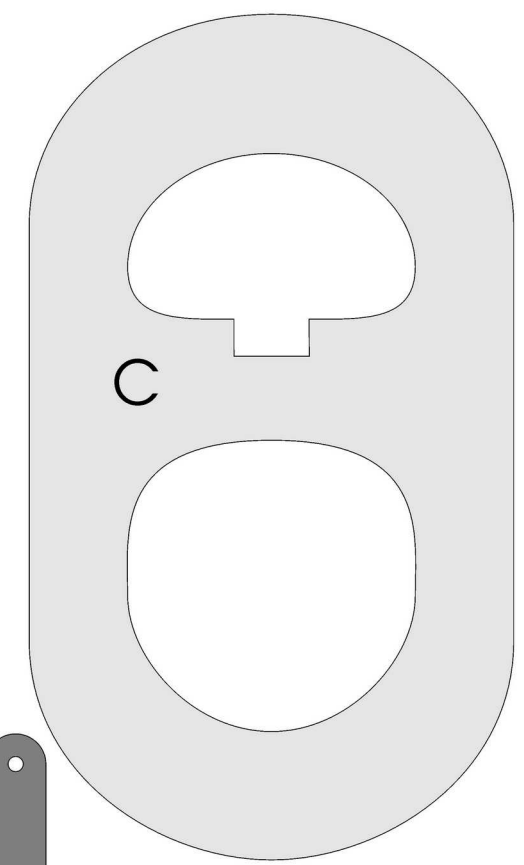
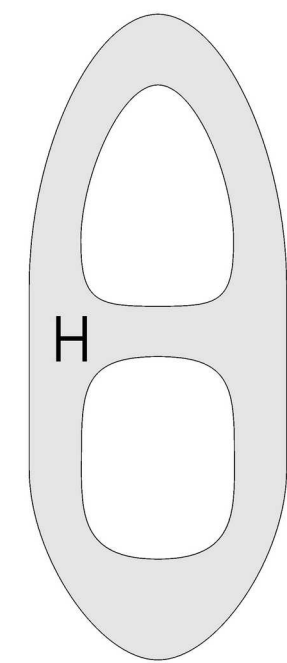

VERTIGO CATORGE

h ... Hüllelemente
i ... Innenkontur
s ... Stützelement

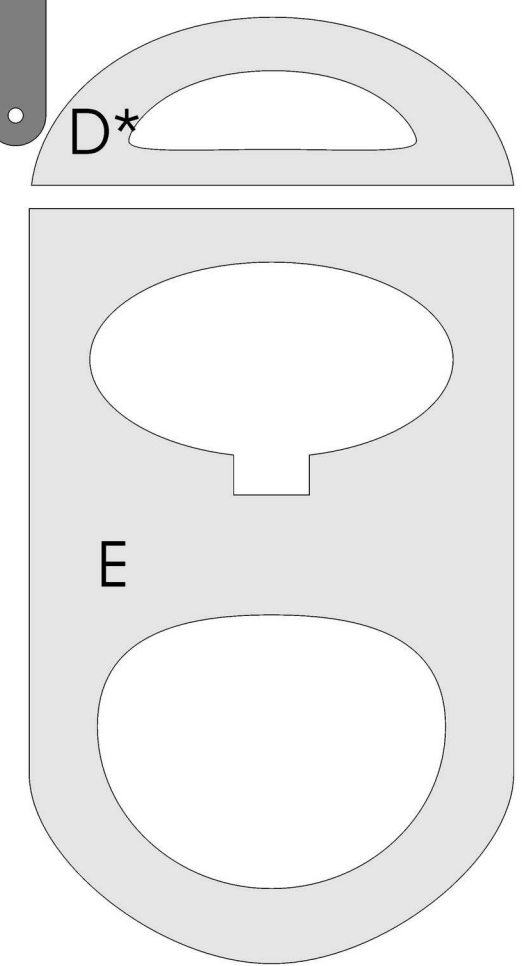
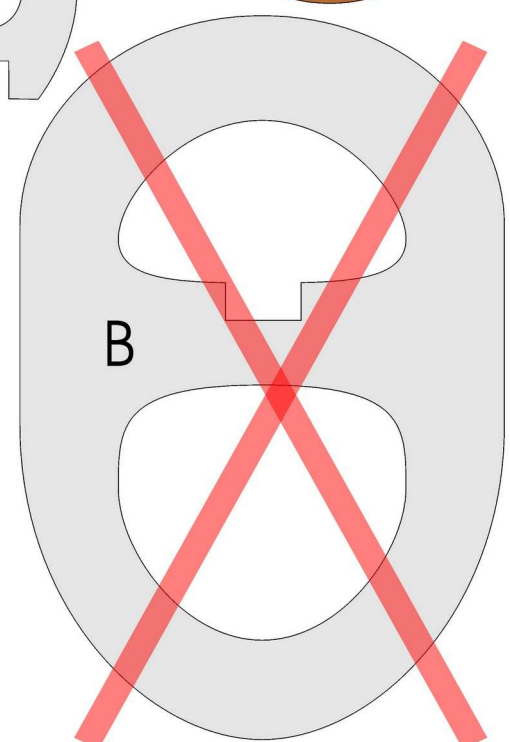
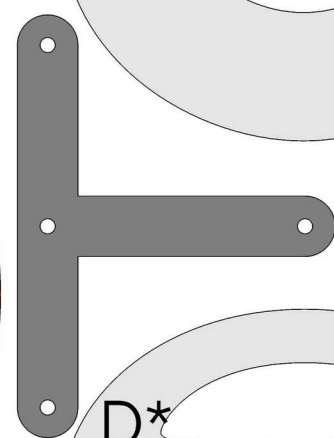
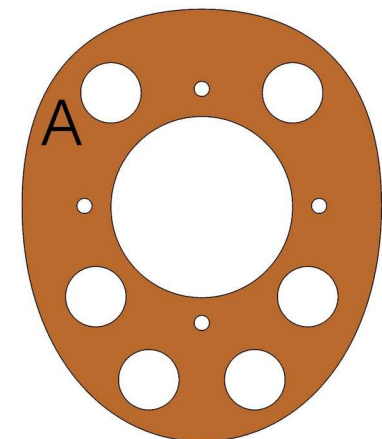
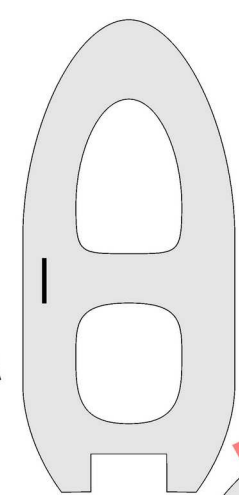
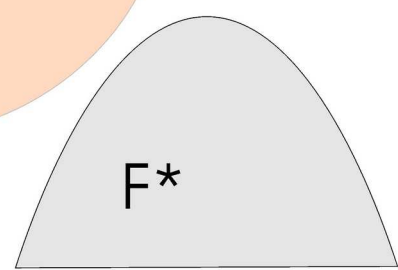
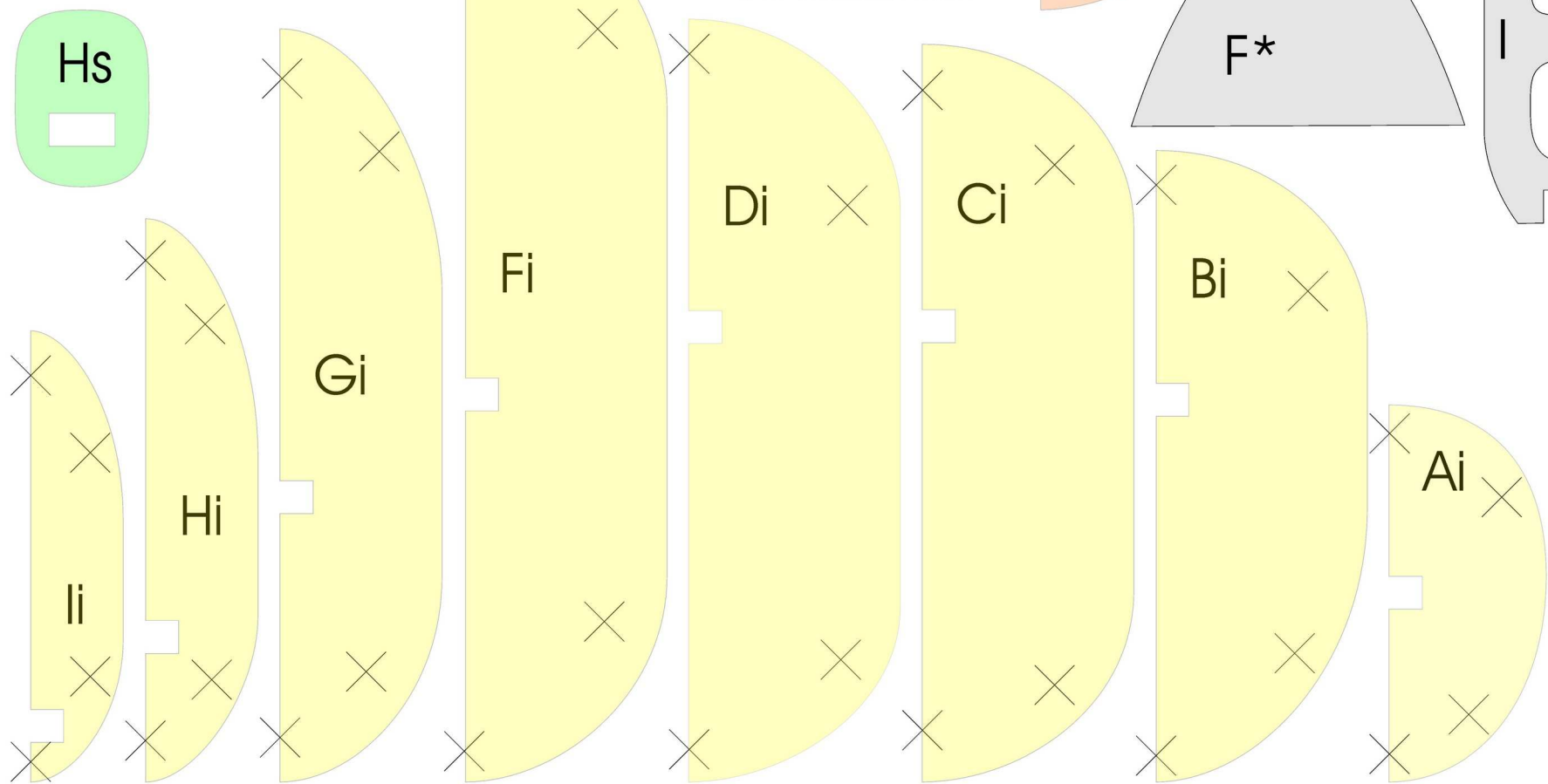

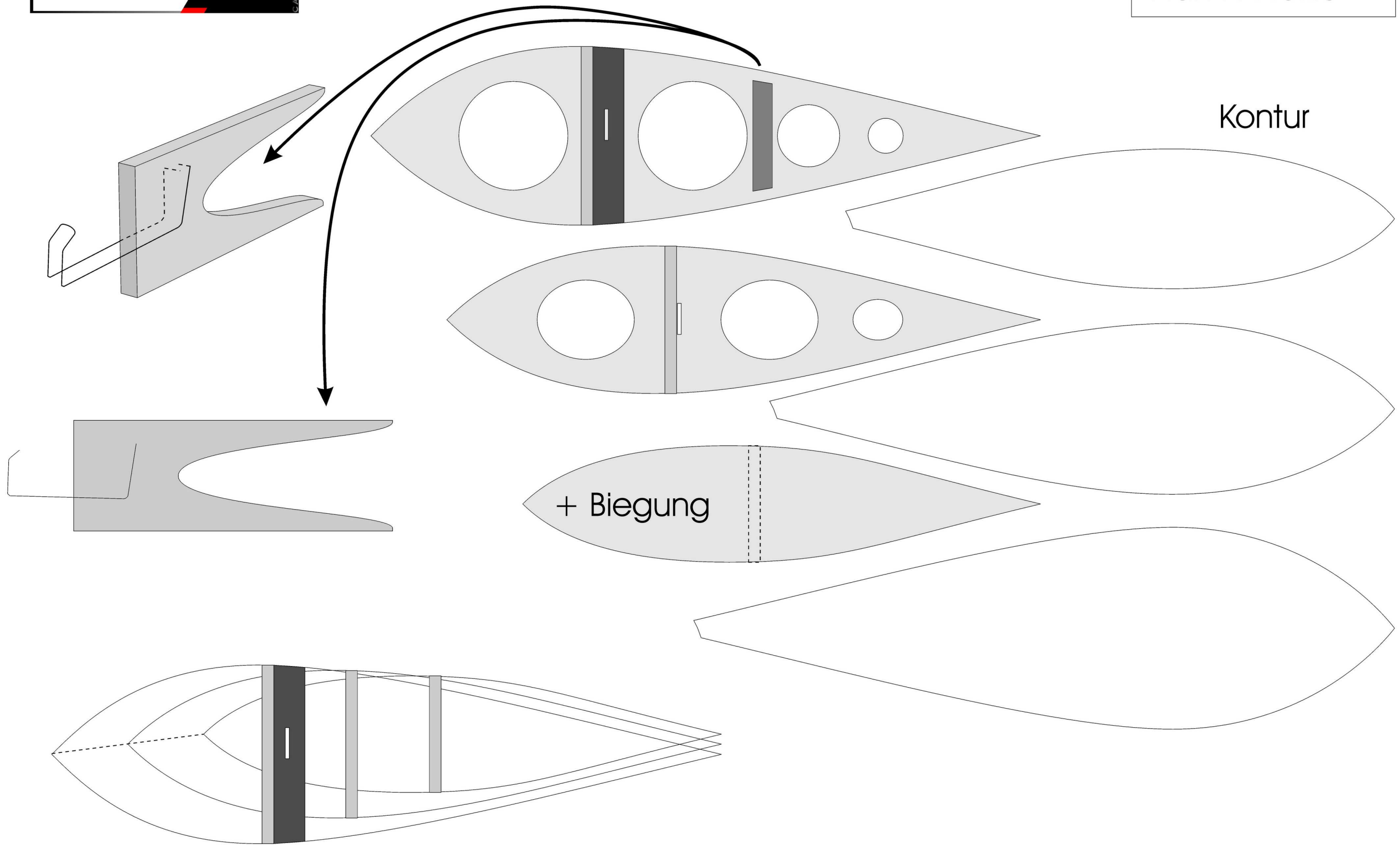

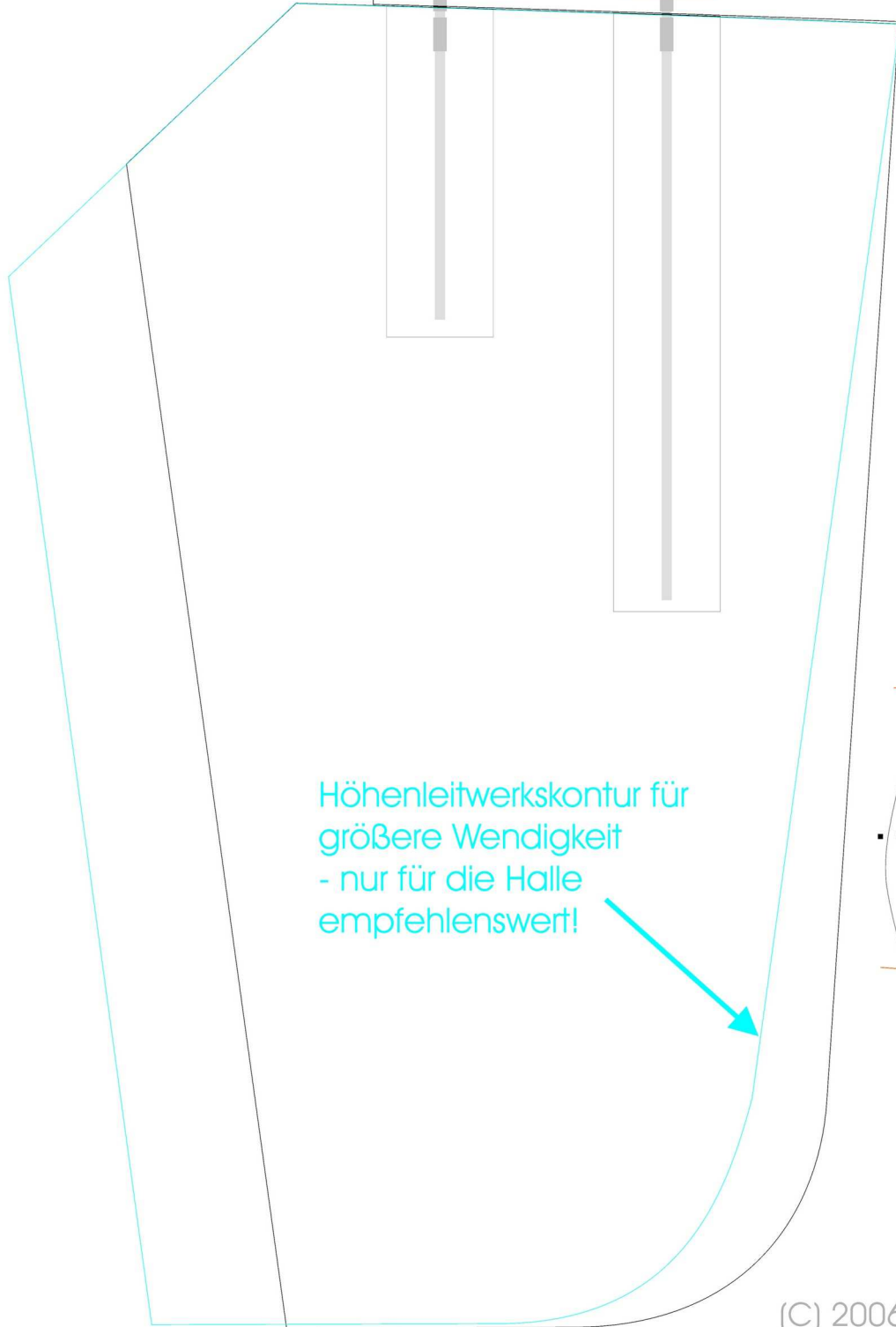
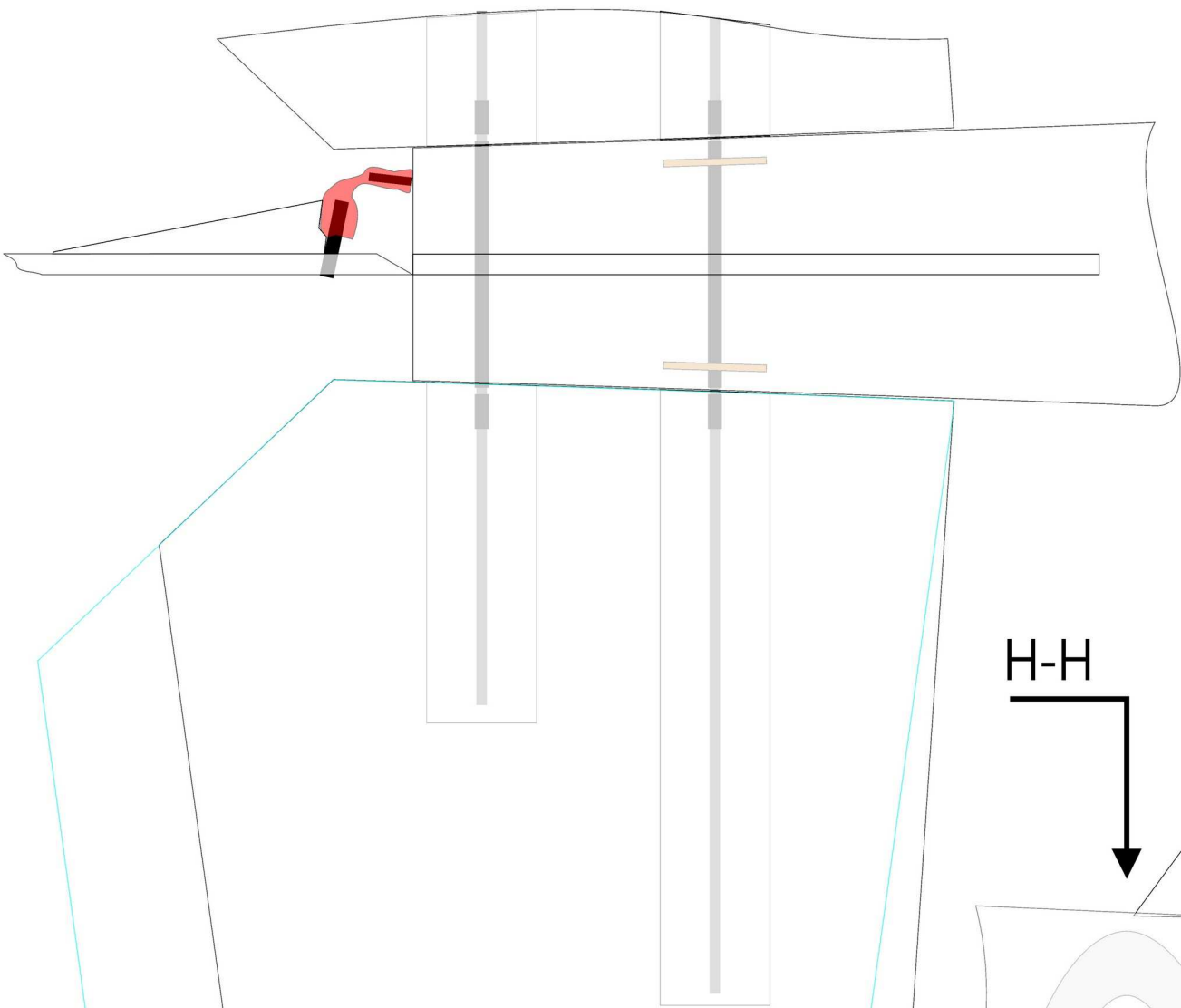

Höhenleitwerkskontur für größere Wendigkeit - nur für die Halle empfehlenswert!

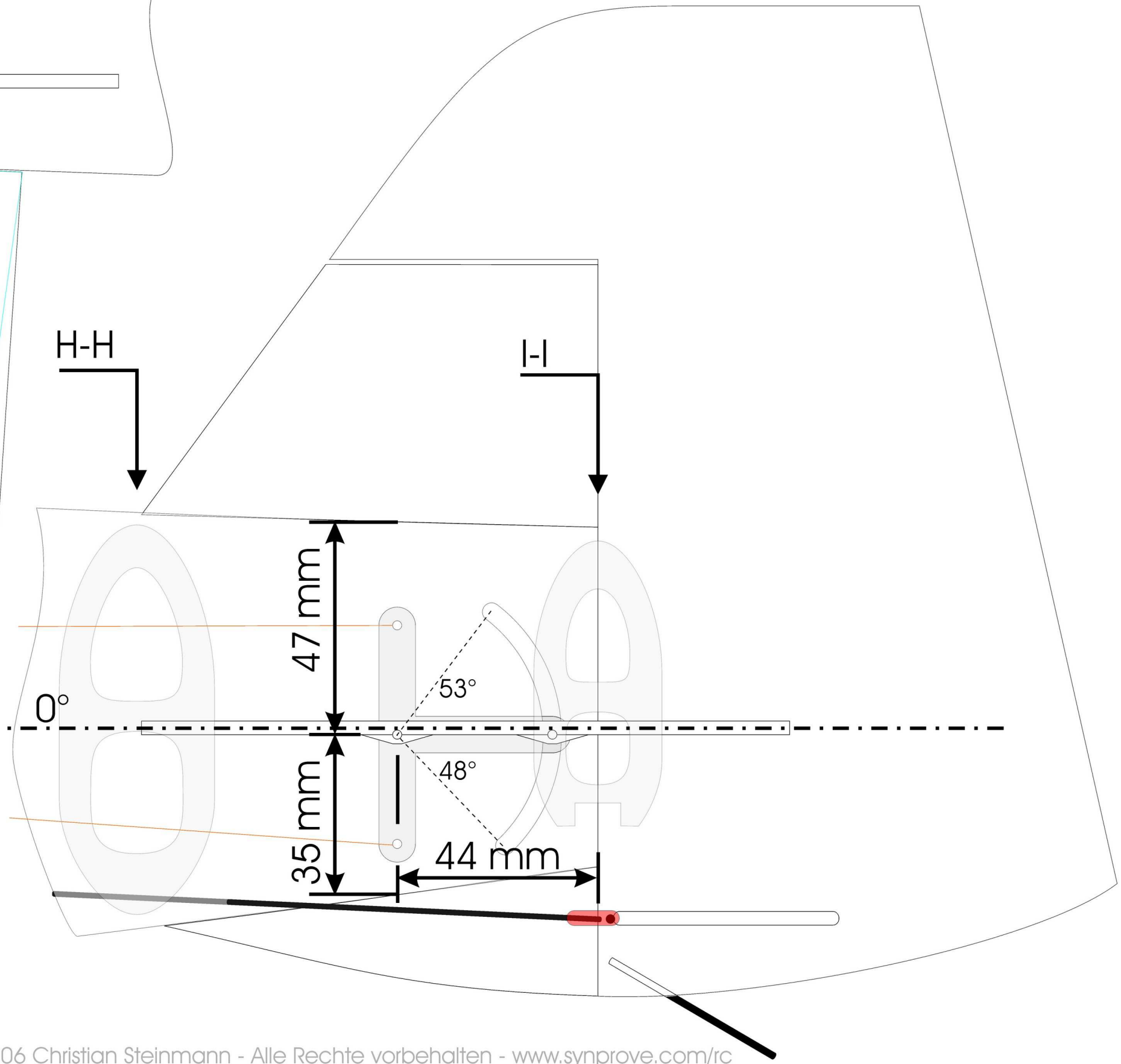

133	222	306	374	443
89	84	68	69	

(C) 2006 Christian Steinmann - Alle Rechte vorbehalten - www.synprove.com/rc

